

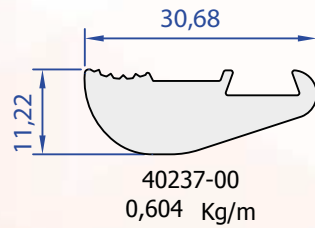

# Electrical Electronical

# Profiles

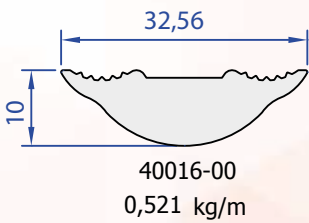

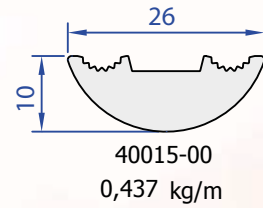
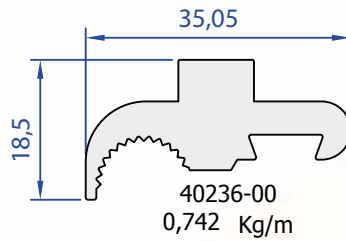
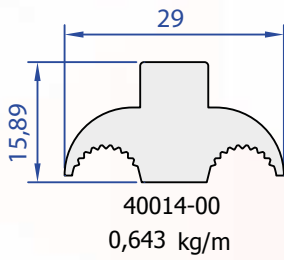
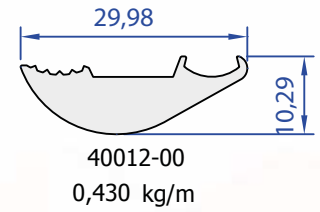
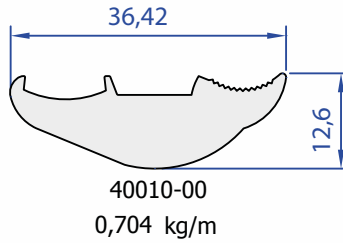
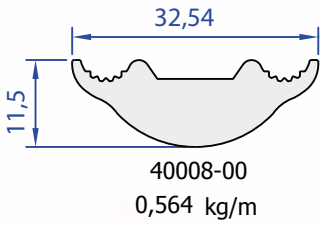
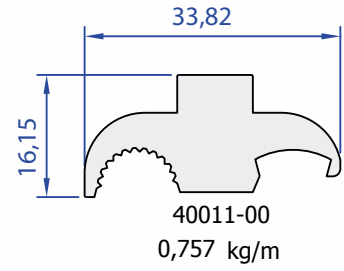
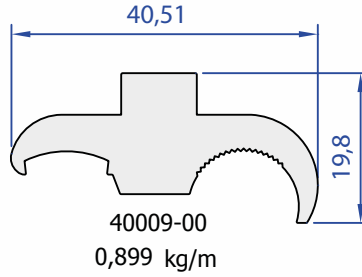
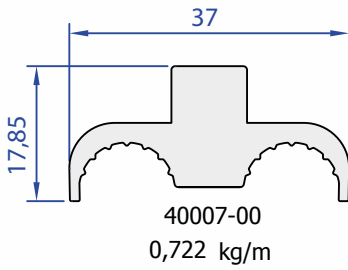
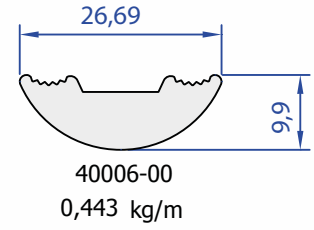
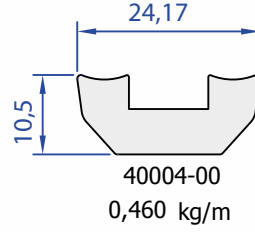
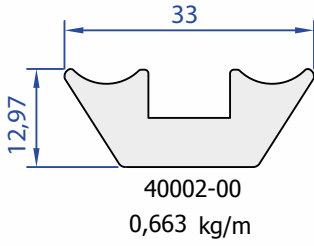
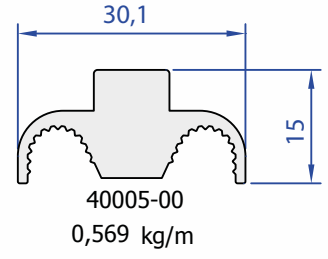
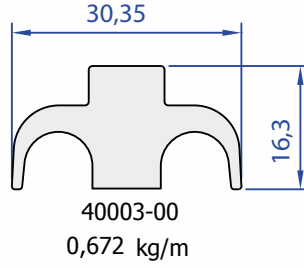
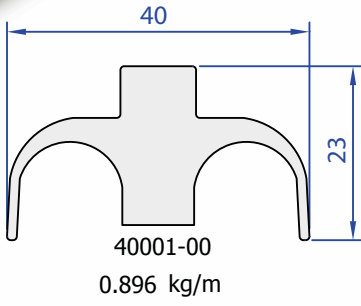
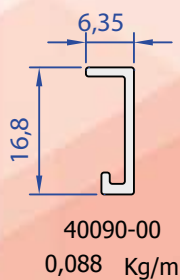
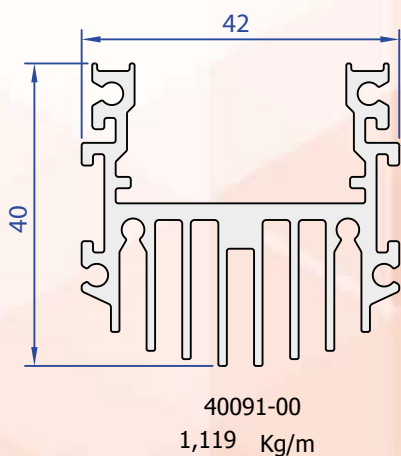
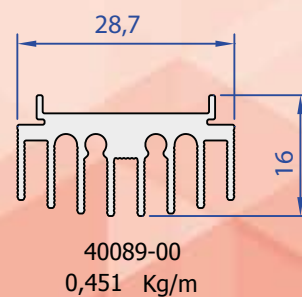
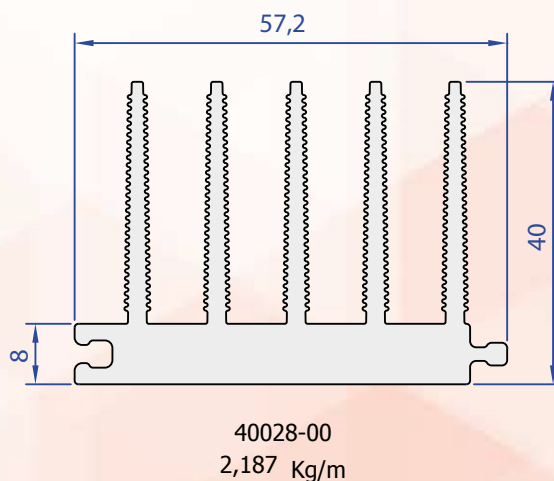
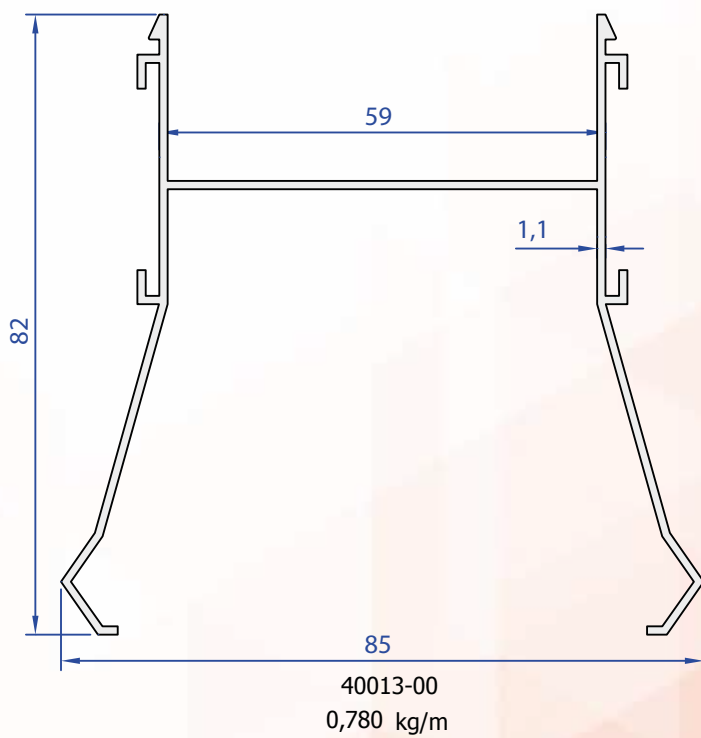
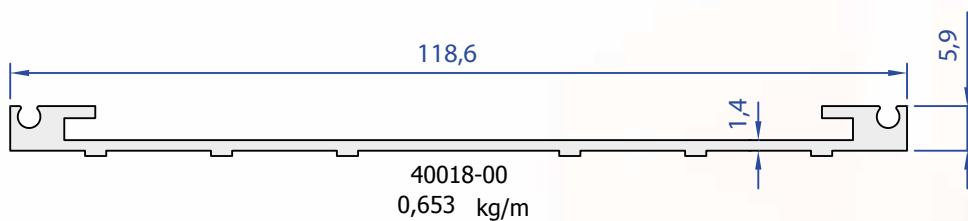
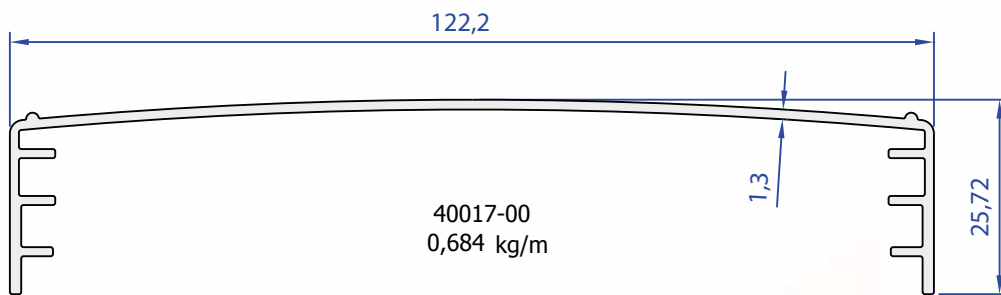

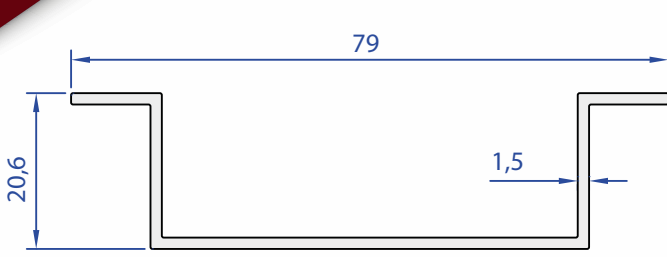

40131-00  
0,477 Kg/m

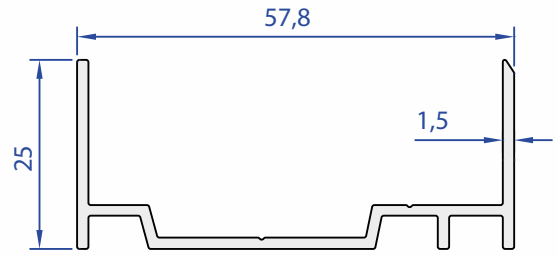

40130-00  
0,462 Kg/m

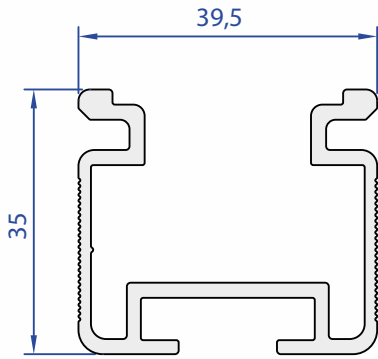

40210-00  
0,792 Kg/m

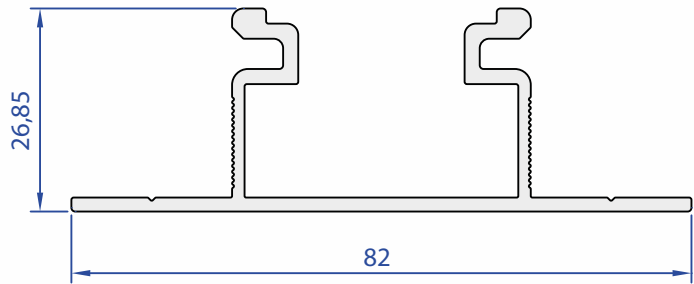

40209-00  
0,803 Kg/m

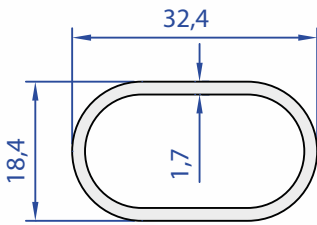

40191-00  
0,370 Kg/m

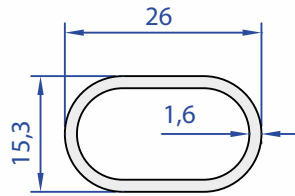

40192-00  
0,279 Kg/m

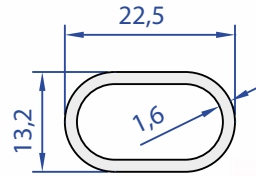

40193-00  
0,239 Kg/m

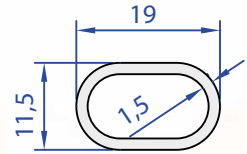

40194-00  
0,189 Kg/m

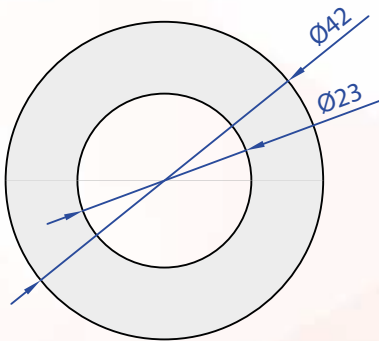

40211-00  
2,629 Kg/m

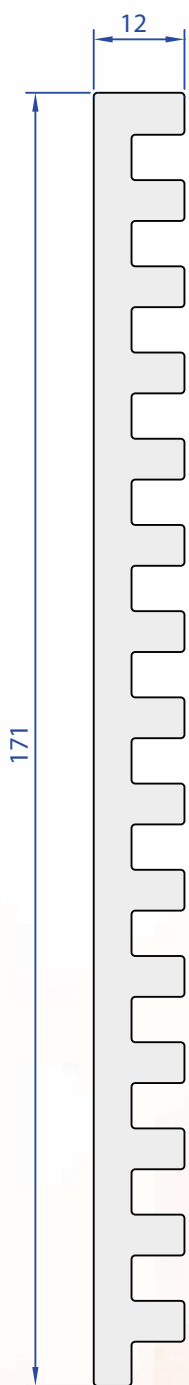

40242-00  
3,856 Kg/m

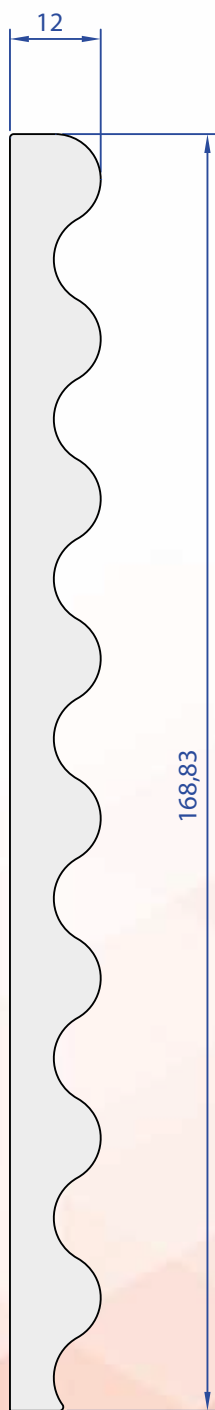

06505-00  
4,066 Kg/m

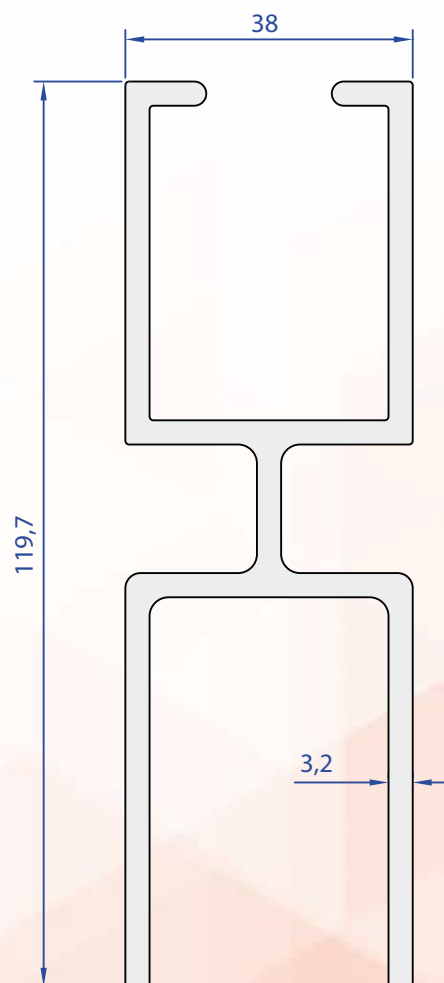

07198-00  
2,617 Kg/m

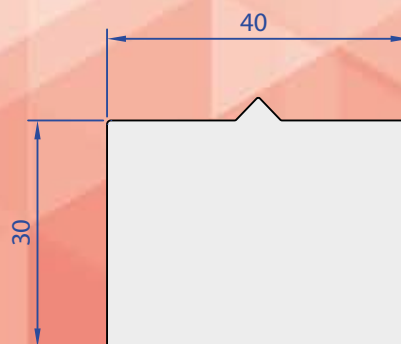

05843-00  
3,263 Kg/m

