



Standard

Profiles

Round Bars

Flat Bars

Square Bars

Angle Bars

U Profiles

T Profiles

Rectangular Tubes

Round Tubes

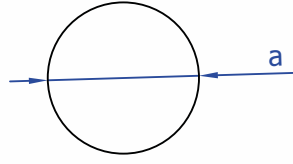

ROUND BARS

PROFILE CODE	a	kg/mt
10001-00	6	0,077
10002-00	6,5	0,090
10003-00	7	0,104
10004-00	7,5	0,120
10005-00	8	0,136
10006-00	8,5	0,154
10007-00	9	0,172
10008-00	9,5	0,192
10009-00	10	0,213
10010-00	10,5	0,235
10011-00	11	0,257
10012-00	11,5	0,281
10013-00	12	0,306
10014-00	12,5	0,332
10015-00	13	0,360
10016-00	13,5	0,388
10017-00	14	0,417
10018-00	14,5	0,447
10019-00	15	0,479
10020-00	15,5	0,511
10021-00	16	0,545
10022-00	16,5	0,579
10023-00	17	0,615
10024-00	17,5	0,652
10025-00	18	0,689
10026-00	18,5	0,728
10027-00	19	0,768
10028-00	19,5	0,809
10029-00	20	0,851
10030-00	20,5	0,894
10031-00	21	0,938
10032-00	21,5	0,983
10033-00	22	1,030
10034-00	22,5	1,077
10035-00	23	1,125
10036-00	23,5	1,175
10037-00	24	1,225

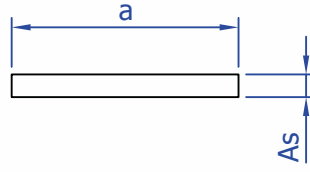

FLAT BARS

PROFILE CODE	a - As	kg/mt
15001-00	30 - 3	0,244
15002-00	25 - 7	0,474
15003-00	15 - 1,5	0,061
15004-00	20 - 1,5	0,081
15005-00	21 - 2	0,108
15006-00	25 - 4	0,271
15007-00	20 - 5	0,271
15008-00	25 - 2	0,136
15009-00	25 - 2,5	0,169
15010-00	25 - 3	0,203
15011-00	25 - 5	0,339
15012-00	30 - 2	0,163
15013-00	30 - 3,5	0,285
15014-00	30 - 5	0,407
15015-00	35 - 2	0,190
15016-00	35 - 3	0,285
15017-00	35 - 5	0,474
15018-00	40 - 2	0,217
15019-00	40 - 3	0,325
15020-00	40 - 5	0,542
15021-00	40 - 10	1,084
15022-00	45 - 3	0,366
15023-00	45 - 5	0,610
15024-00	45 - 10	1,220
15025-00	50 - 3	0,407
15026-00	50 - 5	0,678
15027-00	50 - 10	1,355
15028-00	60 - 3	0,488
15029-00	60 - 5	0,813
15030-00	60 - 10	1,626
15031-00	70 - 5	0,949
15032-00	70 - 10	1,897
15033-00	80 - 5	1,084
15034-00	80 - 10	2,168
15035-00	100 - 5	1,355
15036-00	24 - 4 (Radyüslü)	0,260
15037-00	31 - 2	0,168

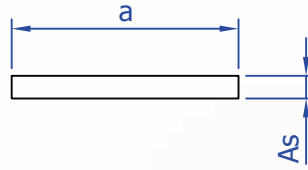

FLAT BARS

PROFILE CODE	a - As	kg/mt
15038-00	20 - 3	0,163
15039-00	13 - 1,5	0,053
15040-00	30 - 10	0,813
15041-00	17,2 - 10	0,466
15042-00	20,5 - 2	0,111
15043-00	4 - 2,9	0,031
15044-00	34,8 - 5	0,472
15045-00	13,5 - 1,6	0,059
15046-00	20 - 10	0,542
15047-00	15,8 - 1	0,043
15048-00	16 - 10	0,434
15049-00	50 - 15	2,033
15050-00	60 - 15	2,439
15051-00	25 - 10	0,678
15052-00	40 - 20	2,168
15053-00	19,5 - 10	0,528
15054-00	50 - 2	0,271
15055-00	28,5 - 3,3	0,255
15056-00	24,4 - 4,6	0,304
15057-00	60 - 1,2	0,130
15058-00	15 - 5	0,203
15059-00	30 - 1,4	0,114
15060-00	40 - 1,4	0,152
15061-00	60 - 1,4	0,228
15062-00	80 - 1,4	0,303
15063-00	100 - 1,4	0,379
15064-00	15 - 3	0,122
15065-00	22 - 2	0,119
15066-00	20 - 2 (radyüslü)	0,271
15067-00	100 - 10	2,710
15068-00	100 - 8	2,168
15069-00	63 - 10	1,707
15070-00	80 - 6,9 (radyüslü)	1,468
15071-00	12 - 7	0,227
15072-00	60 - 8	1,300
15073-00	63 - 8	1,366
15074-00	40 - 4	0,434

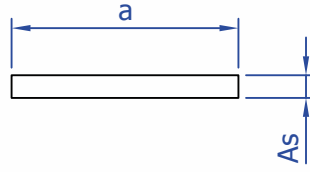

FLAT BARS

PROFILE CODE	a - As	kg/mt
15075-00	150 - 1,4	0,569
15076-00	22 - 2,5	0,149
15077-00	14,5 - 3	0,118
15078-00	10 - 5	0,135
15079-00	30 - 20	1,626
15080-00	15,5 - 3	0,126
15081-00	10 - 3	0,081
15082-00	55 - 3	0,447
15083-00	18 - 3	0,146
15084-00	33,6 - 4,1	0,373
15085-00	60 - 20	3,252
15086-00	30 - 4,5	0,366
15087-00	48 - 10	1,301
15088-00	25,5 - 2	0,138
15089-00	40 - 1,2	0,130
15090-00	45 - 1,2	0,146
15091-00	45 - 2	0,244
15092-00	53 - 2	0,287
15093-00	32 - 3,8	0,330
15094-00	20 - 4	0,217
15095-00	29,8 - 3,8	0,307
15097-00	147 - 4,8	1,912
15098-00	20 - 2	0,109
15099-00	80 - 4	0,867
15100-00	45 - 23	2,805
15101-00	53 - 2	0,287
15102-00	45 - 17	2,073
15103-00	45 - 34	4,146
15104-00	88 - 4	0,953
15105-00	120 - 4	1,301
15107-00	49 - 5	0,663
15108-00	23 - 7	0,436

ANGLE BARS

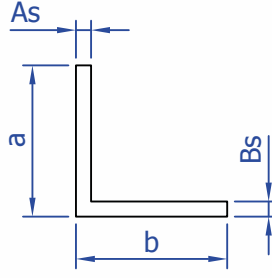

PROFILE CODE	(a x b) - As -Bs	kg/mt
20001-00	(40 X 60) - 1,5 - 1,5	0,400
20002-00	(60 X 60) - 6 - 6	1,854
20003-00	(70 X 40) - 4 - 4	1,149
20004-00	(20 X 40) - 3 - 3	0,463
20005-00	(28 X 60) - 2,3 - 1,5	0,409
20006-00	(20 X 40) - 1,2 - 1,2	0,191
20007-00	(20 X 60) - 1,2 - 1,2	0,256
20008-00	(15 X 15) - 1,2 - 1,2	0,094
20009-00	(15 X 15) - 2 - 2	0,152
20010-00	(20 X 20) - 1,2 - 1,2	0,126
20011-00	(20 X 20) - 2 - 2	0,206
20012-00	(20 X 30) - 1,2 - 1,2	0,159
20013-00	(20 X 40) - 2 - 2	0,314
20014-00	(25 X 25) - 1,2 - 1,2	0,159
20015-00	(25 X 25) - 3 - 3	0,382
20016-00	(30 X 30) - 1,2 - 1,2	0,191
20017-00	(30 X 30) - 2 - 2	0,314
20018-00	(30 X 30) - 3 - 3	0,463
20019-00	(40 X 40) - 2 - 2	0,423
20020-00	(40 X 40) - 4 - 4	0,824
20021-00	(50 X 30) - 2 - 2	0,423
20022-00	(50 X 50) - 2 - 2	0,531
20023-00	(50 X 50) - 5 - 5	1,287
20024-00	(60 X 60) - 3 - 3	0,951
20025-00	(60 X 60) - 5 - 5	1,558
20026-00	(100 X 20) - 2 - 2	0,640
20027-00	(40 X 40) - 1,2 - 1,2	0,256
20028-00	(20 X 20) - 1,5 - 1,5	0,157
20029-00	(40 X 35,5) - 4 - 4	0,775
20030-00	(36,5 X 10) - 1,5 - 1,5	0,183
20031-00	(36,5 X 5) - 1,5 - 1,5	0,163
20032-00	(10 X 5) - 1,5 - 1,5	0,055
20033-00	(60 X 40) - 1,2 - 1,2	0,321
20034-00	(50 X 50) - 1,2 - 1,2	0,321
20035-00	(40 X 40) - 5 - 5	1,016
20036-00	(10 X 10) - 1,5 - 1,5	0,075
20037-00	(20 X 20) - 0,9 - 0,9	0,095

ANGLE BARS

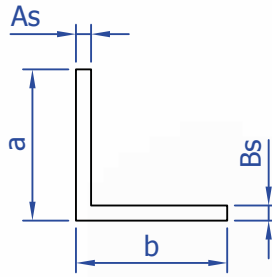

PROFILE CODE	(a x b) - As -Bs	kg/mt
20038-00	(40 X 40) - 3 - 3	0,626
20039-00	(18 X 25) - 7 - 2	0,439
20040-00	(40 X 30) - 1,5 - 1,5	0,279
20041-00	(20 X 10) - 1,5 - 1,5	0,116
20042-00	(40 X 30) - 1,2 - 1,2	0,224
20043-00	(30 X 50) - 1,2 - 1,2	0,256
20044-00	(50 X 40) - 1,2 - 1,2	0,289
20045-00	(30 X 80) - 1,3 - 1,3	0,383
20046-00	(20 X 60) - 1,5 - 1,5	0,319
20047-00	(28 X 53) - 2 - 2	0,428
20048-00	(13 X 55) - 1,3 - 1,3	0,235
20049-00	(10 X 15) - 1,5 - 1,5	0,096
20050-00	(60 X 60) - 1,5 - 1,5	0,481
20051-00	(50 X 20) - 1,5 - 1,5	0,279
20052-00	(50 X 50) - 3 - 3 (İÇ RADYÜSLÜ)	0,794
20053-00	(20 X 15) - 1,8 - 1,8	0,162
20054-00	(30 X 30) - 4 - 4	0,607
20055-00	(17 X 17) - 1 - 1	0,089
20056-00	(20 X 60) - 2 - 2	0,423
20057-00	(20 X 30) - 2 - 2	0,260
20058-00	(20 X 80) - 1,2 - 1,2	0,321
20059-00	(30 X 57) - 1 - 1	0,233
20060-00	(3 X 57) - 1 - 1	0,160
20061-00	(7 X 13) - 1,2 - 1,2	0,061
20062-00	(18 X 18) - 0,8 - 0,8	0,076
20063-00	(20 X 40) - 1,5- 1,5	0,238
20064-00	(50 X 100) - 2 - 2	0,802
20065-00	(25 X 25) - 2 - 2	0,260
20066-00	(40 X 60) - 2 - 2	0,531
20067-00	(30 X 10) - 1,2 - 1,2	0,126
20068-00	(50 X 30) - 3 - 3	0,626
20069-00	(70 X 50) - 3 - 3	0,951
20070-00	(70 X 50) - 5 - 5	1,558
20071-00	(60 X 40) - 5 - 5	1,287
20072-00	(30 X 30) - 1,5 - 1,5	0,238
20073-00	(10 X 10) - 1,1 - 1,1	0,056
20074-00	(15 X 30) - 1,2 - 1,2	0,143

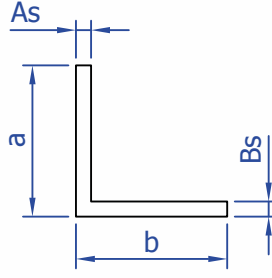

ANGLE BARS

PROFILE CODE	(a x b) - As -Bs	kg/mt
20075-00	(30 X 60) - 2 - 2	0,477
20076-00	(30 X 48) - 2 - 2	0,412
20077-00	(10,5 X 42,8) - 1,3 - 1,3	0,183
20078-00	(18 X 55) - 3 - 3	0,569
20079-00	(15 X 29) - 1,5 - 1,5	0,173
20080-00	(20 X 20) - 1 - 1	0,106
20081-00	(20 X 30) - 1,3 - 1,3	0,171
20082-00	(30 X 30) - 1,3 - 1,3	0,207
20083-00	(20 X 20) - 1,3 - 1,3	0,136
20084-00	(20 X 100) - 3 - 3	0,951
20085-00	(20 X 50) - 1,2 - 1,2	0,224
20086-00	(57 X 10) - 1 - 1	0,178
20087-00	(52,63 X 10) - 1,3 - 1,3	0,216
20088-00	(100 X 20) - 1,3 - 1,3	0,418
20089-00	(190 X 20) - 2 - 2	1,127
20090-00	(150 X 20) - 2 - 2	0,911
20091-00	(90 X 40) - 3 - 3	1,033
20092-00	(46,43 X 12,4) - 1,5 - 1,5	0,233
20093-00	(40 X 10) - 1,2 - 1,2	0,159
20094-00	(90 X 60) - 3 - 3	1,195
20095-00	(110 X 60) - 3 - 3	1,358
20096-00	(25 X 10) - 2 - 2	0,179
20097-00	(20 X 15) - 1 - 1	0,092
20098-00	(20 X 40) - 1 - 1	0,160
20099-00	(15 X 15) - 3 - 3	0,220
20100-00	(32 X 20) - 2 - 2	0,271
20101-00	(20 X 125) - 1,8 - 1,8	0,699
20102-00	(35 X 13) - 2 - 2	0,250
20103-00	(70 X 50) - 2 - 2	0,640
20104-00	(9 X 35) - 3 - 3	0,333
20105-00	(9 X 35) - 5 - 5	0,610
20106-00	(50 X 90) - 4 - 4	1,474
20107-00	(50 X 50) - 3 - 3	0,789
20108-00	(50 X 55) - 8 - 8	2,103
20109-00	(50 X 60) - 8 - 8	2,211
20110-00	(46 X 28) - 1 - 1	0,198
20111-00	(40 X 25) - 1,2 - 1,2	0,207

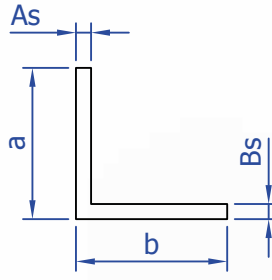

ANGLE BARS

PROFILE CODE	(a x b) - As -Bs	kg/mt
20112-00	(54,5 X 23,4) - 1,3 - 1,3	0,270
20113-00	(45 X 20) - 2 - 2	0,341
20115-00	(15 X 10) - 1 - 1	0,065
20116-00	(15 X 5) - 1 - 1	0,052
20117-00	(55 X 15) - 1,3 - 1,3	0,341

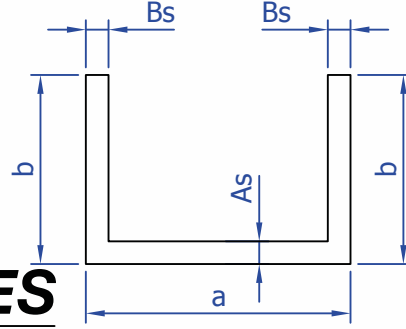

U PROFILES

PROFILE CODE	(a x b) - As -Bs	kg/mt
21001-00	(16,5 X 10) - 1,5 - 1,5	0,136
21002-00	(20 X 18) - 1 - 1	0,146
21003-00	(20,5 X 10,5) - 3 - 3	0,289
21004-00	(18 X 20) - 1 - 1	0,152
21005-00	(18 X 18) - 1 - 1	0,141
21006-00	(90 X 20) - 2,5 - 2,5	0,847
21007-00	(21,5 X 21,5) - 1,5 - 1,5	0,250
21008-00	(21 X 25) - 1,2 - 1,2	0,223
21009-00	(90 X 20) - 2 - 2	0,683
21010-00	(43 X 21) - 1 - 1	0,225
21011-00	(43 X 11,5) - 1 - 1	0,173
21012-00	(120 X 30) - 2 - 2	0,954
21013-00	(8 X 8) - 1 - 1	0,060
21014-00	(19,9 X 10) - 1,2 - 1,2	0,122
21015-00	(44 X 8) - 1 - 1	0,157
21016-00	(40 X 40) - 4 - 4	1,214
21017-00	(10 X 10) - 1 - 1	0,076
21018-00	(17 X 17) - 1,2 - 1,2	0,158
21019-00	(21 X 25) - 1,5 - 1,5	0,276
21020-00	(21 X 25) - 1 - 1	0,187
21021-00	(21,3 X 25,2) - 1,4 - 1,4	0,259
21022-00	(38 X 55,76) - 4,85 - 4,85 (Pahlı)	1,822
21023-00	(57 X 58,18) - 4,85 - 4,85 (Pahlı)	2,080
21024-00	(16 X 14,5) - 1,5 - 1,5	0,171
21025-00	(45,2 X 16,1) - 0,9 - 0,9	0,184
21026-00	(13,2 X 15) - 1,2 - 1,2	0,133
21027-00	(18,5 X 26) - 1,5 - 1,5	0,275
21028-00	(35 X 20) - 1,8 - 1,8	0,348
21029-00	(72 X 40) - 2,5 - 2,5	0,996
21030-00	(15 X 20) - 1,5 - 1,5	0,211
21031-00	(19,5 X 15) - 1 - 1	0,129
21032-00	(40,3 X 63,98) - 5 - 5 (Pahlı)	2,137
21033-00	(40 X 40) - 3 - 3	0,927
21034-00	(27,6 X 20) - 0,8 - 0,8	0,143
21035-00	(15 X 10) - 1,5 - 1,5	0,130
21036-00	(30 X 30) - 3 - 3	0,682
21037-00	(44 X 30) - 1,2 - 1,2	0,330

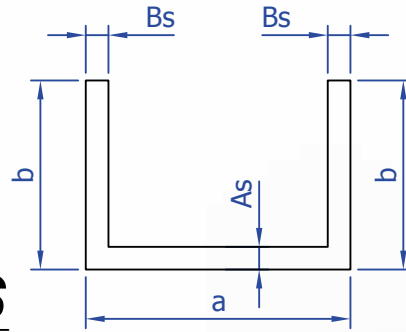

U PROFILES

PROFILE CODE	(a x b) - As -Bs	kg/mt
21038-00	(23,3 X 20) - 0,9 - 0,9	0,150
21039-00	(34,1 X 15) - 0,8 - 0,8	0,135
21040-00	(30 X 20) - 2 - 2	0,357
21041-00	(50 X 15) - 1,5 - 1,5	0,313
21042-00	(23 X 23) - 3 - 3	0,512
21043-00	(24 X 23) - 1,5 - 1,5	0,272
21044-00	(49,8 X 19,7) - 1,5 - 1,5	0,350
21045-00	(120,5 X 30,2) - 2 - 2	0,958
21046-00	(170 X 30) - 2 - 2	1,224
21047-00	(23,3 X 12) - 0,9 - 0,9	0,111
21048-00	(14 X 12) - 2 - 2	0,184
21049-00	(18,5 X 10) - 1,5 - 1,5	0,144
21050-00	(16,3 X 6) - 1,2 - 1,2	0,084
21051-00	(15,5 X 10) - 1,5 - 1,5	0,133
21052-00	(12 X 12) - 1,5 - 1,5	0,134
21053-00	(20,9 X 10) - 1,2 - 1,2	0,125
21054-00	(12,4 X 11,5) - 2 - 2 pahli	0,173
21055-00	(30 X 8) - 2 - 2	0,228
21056-00	(36 X 16,2) - 1 - 1	0,179
21057-00	(8 X 13) - 0,8 - 0,8	0,070
21058-00	(17 X 15) - 1,2 - 1,2	0,145
21059-00	(36,4 X 9) - 3 - 3	0,394
21060-00	(16 X 10) - 1,6 - 1,6	0,142
21061-00	(27,2 X 29,5) - 1,1 - 1,1	0,249
21062-00	(38,3 X 16,1) - 0,9 - 0,9	0,165
21063-00	(40 X 10) - 1,5 - 1,5	0,232
21064-00	(60 X 30) - 1,5 - 1,5	0,474
21065-00	(16 X 28) - 2 - 2	0,368
21066-00	(17 X 16) - 1,1 - 1	0,131

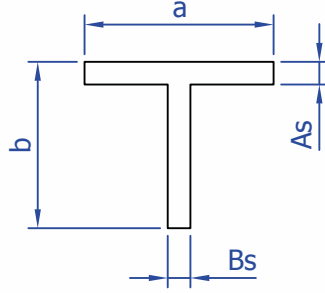

T PROFILES

PROFILE CODE	(a x b) - As -Bs	kg/mt
25001-00	(15 X 15) - 1,2 - 1,2	0,094
25002-00	(20 X 20) - 1,2 - 1,2	0,126
25003-00	(25 X 25) - 1,2 - 1,2	0,159
25004-00	(25 X 25) - 2 - 2	0,260
25005-00	(30 X 30) - 1,2 - 1,2	0,191
25006-00	(30 X 30) - 1,5 - 1,5	0,238
25007-00	(30 X 30) - 2 - 2	0,314
25008-00	(40 X 40) - 2 - 2	0,423
25009-00	(40 X 40) - 4 - 4	0,824
25010-00	(40 X 30) - 3 - 3	0,545
25011-00	(12 X 12) - 1,2 - 1,2 (RADYÜSLÜ)	0,074
25012-00	(30 X 20) - 2 - 2 (ASİMETRİK)	0,260
25013-00	(60 X 60) - 2 - 2	0,639
25014-00	(5 X 13) - 1 - 1	0,046
25015-00	(20 X 30) - 1 - 1	0,133
25016-00	(21 X 15) - 1 - 1 (ASİMETRİK)	0,095
25017-00	(40 X 19) - 3 - 5 (ASİMETRİK)	0,542
25018-00	(25 X 20) - 1,2 - 1,2 (ASİMETRİK)	0,142
25019-00	(20 X 20) - 1 - 1	0,105
25020-00	(40 X 12) - 2 - 2	0,271
25021-00	(10 X 10) - 1,2 - 1,2	0,061
25022-00	(55 X 75) - 7 - 6 (ASİMETRİK)	2,150
25023-00	(50 X 50) - 2 - 2	0,531
25024-00	(100 X 50) - 2 - 2	0,802
25025-00	(35 X 30) - 1,2 - 1,2	0,208
25026-00	(25 X 17,5) - 2,5 - 2,5	0,271
25027-00	(9,2 X 30) - 1,2 - 1,2	0,123
25028-00	(50 X 50) - 2,3 - 2,3	0,609
25029-00	(50 X 25) - 1,2 - 1,2	0,240

RECTANGULAR TUBES

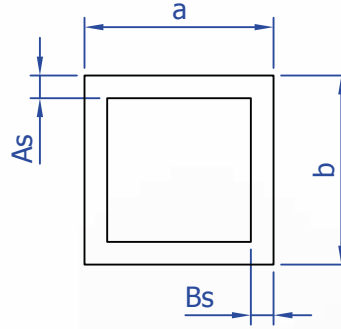

PROFILE CODE	(a x b) - As - Bs	kg/mt
30001-00	(50 x 20) - 1,4 - 1,4	0,510
30002-00	(15 x 15) - 1 - 1	0,152
30003-00	(45 x 45) - 2 - 2	0,905
30004-00	(71 x 31) - 1 - 1	0,542
30005-00	(66 x 26) - 1 - 1	0,488
30006-00	(40 x 20) - 1 - 1	0,314
30007-00	(30 x 20) - 1,5 - 1,5	0,382
30008-00	(70 x 50) - 2,5 - 2,5	1,558
30009-00	(30 x 30) - 1,8 - 1,8	0,550
30010-00	(25 x 17) - 1,2 - 1,2	0,258
30011-00	(40 x 20) - 2 - 2	0,607
30012-00	(55 x 55) - 2 - 2	1,144
30013-00	(25 x 25) - 2 - 2 (R3 radyüslü)	0,480
30014-00	(75 x 32) - 2 - 2	1,116
30015-00	(20 x 20) - 1,5 - 1,5	0,301
30016-00	(20 x 20) - 1,2 - 1,2	0,244
30017-00	(50 x 40) - 1,2 - 1,2	0,570
30018-00	(17 x 17) - 1,2 - 1,2	0,205
30019-00	(60 x 60) - 1,5 - 1,5	0,951
30020-00	(40 x 80) - 1,5 - 1,5	0,951
30021-00	(40 x 40) - 1,2 - 1,2	0,505
30022-00	(29,4 x 29,4) - 1,5 - 1,5	0,454
30023-00	(40 x 20) - 1,5 - 1,5	0,463
30024-00	(40 x 80) - 2 - 2	1,257
30025-00	(25 x 65) - 0,95 - 0,95	0,477
30026-00	(32 x 75) - 1,1 - 1,1	0,625
30027-00	(57 x 57) - 3 - 3	1,756
30028-00	(63 x 23) - 1 - 1	0,433
30029-00	(44 x 44) - 1 - 1 (ÇİZGİLİ)	0,464
30030-00	(23 x 63) - 0,9 - 0,9	0,366
30031-00	(30 x 70) - 0,9 - 0,9	0,427
30032-00	(10 x 10) - 1,2 - 1,2	0,114
30033-00	(39,8 x 19,8) - 0,9 - 0,9	0,282
30034-00	(16 x 16) - 1 - 1	0,162
30035-00	(50 x 30) - 2,5 - 2,5	1,016
30036-00	(40 x 20) - 2 - 2 (radyüslü)	0,523
30037-00	(51,6 x 41,6) - 2 - 2	0,967
30038-00	(40 x 60) - 1.3 - 1.3	0,686

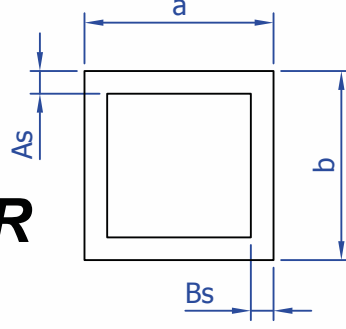

RECTANGULAR TUBES

PROFILE CODE	(a x b) - As - Bs	kg/mt
30039-00	(25 x 25) - 2 - 2 (R1 radyüslü)	0,501
30040-00	(12 x 6) - 1 - 1	0,086
30041-00	(90 x 50) - 2 - 2	1,474
30042-00	(80 x 80) - 1,6 - 1,6	1,360
30043-00	(120 x 60) - 5 - 5	4,607
30044-00	(100 x 40) - 4 - 4	2,862
30045-00	(12 x 12) - 1 - 1	0,119
30046-00	(100 x 15) - 2 - 2	1,203
30047-00	(40 x 25) - 5 - 5	2,710
30048-00	(20 x 50) - 2 - 2	0,716
30049-00	(60 x 20) - 2 - 2	0,824
30050-00	(145 x 74) - 3 - 3	3,463
30051-00	(30 x 20) - 2 - 2	0,499
30052-00	(18,6 x 16,2) - 1,2 - 1,2	0,227
30053-00	(18 x 16) - 1 - 1	0,184
30054-00	(90,5 x 60,5) - 5 - 5	3,821
30055-00	(100 x 50) - 3 - 3	2,341
30056-00	(60 x 60) - 2 - 2	1,257
30057-00	(40 x 40) - 4 - 4	1,561
30058-00	(60 x 40) - 4 - 4 (R3 radyüslü)	1,995
30059-00	(30 x 15) - 2 - 2 (R1 radyüslü)	0,442
30060-00	(70 x 20) - 1,3 - 1,3	0,616
30061-00	(80 x 60) - 2 - 2	1,474

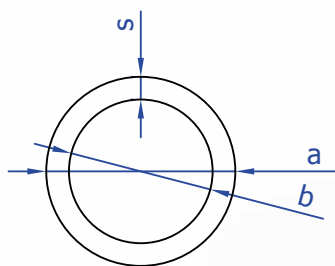

ROUND TUBES

PROFILE CODE	(a x b) - s	kg/mt
35001-00	(8 x 6) - 1	0,060
35002-00	(21,8 x 19,6) - 1,1	0,194
35003-00	(18,8 x 16,6) - 1,1	0,166
35004-00	(25 x 21) - 2	0,392
35005-00	(12 x 9) - 1,5	0,134
35006-00	(29,5 x 25) - 2,25	0,522
35007-00	(45 x 40,1) - 2,45	0,905
35008-00	(50 x 46) - 2	0,817
35009-00	(20,8 x 17) - 1,9	0,305
35010-00	(29,3 x 25,5) - 1,9	0,443
35011-00	(26 x 21) - 2,5	0,500
35012-00	(24,8 x 22,6) - 1,1	0,222
35013-00	(40 x 34) - 3	0,945
35014-00	(7,7 x 6) - 0,85	0,050
35015-00	(28 x 25,2) - 1,4	0,317
35016-00	(12 x 10) - 1	0,094
35017-00	(25 x 22,6) - 1,2	0,243
35018-00	(16 x 13) - 1,5	0,185
35019-00	(19,5 x 17,5) - 1	0,156
35020-00	(42 x 38) - 2	0,681
35021-00	(70 x 67) - 1,5	0,874
35022-00	(60 x 57) - 1,5	0,747
35023-00	(18 x 15,8) - 1,1	0,158
35024-00	(9 x 7) - 1	0,068
35025-00	(20 x 15) - 2,5	0,372
35026-00	(28 x 26) - 1	0,230
35027-00	(7 x 5) - 1	0,051
35028-00	(10 x 8) - 1	0,077
35029-00	(24,6 x 19) - 2,8	0,520
35030-00	(20 x 17) - 1,5	0,236
35031-00	(14 x 10) - 2	0,204
35032-00	(11,85 x 10) - 0,92	0,086
35033-00	(71 x 67) - 2	1,175
35034-00	(75 x 65) - 5	2,980
35035-00	(20 x 18) - 1	0,162
35036-00	(6,8 x 5) - 0,9	0,045
35037-00	(41 x 38) - 1,5	0,504
35038-00	(9,5 x 7,5) - 1	0,073

